



CTVT  
Standard version



CTVT INS  
Acoustic version

Range of centrifugal roof mounted fans in vertical discharge format, designed for smoke extraction in fire conditions suitable for F400-120 application, base parts manufactured in galvanised sheet steel, cowls manufactured from spun aluminium, centrifugal backward curved impellers manufactured in double coated painted sheet steel (cataphoresis + polyester), discharge proof guard, and ON-OFF electrical isolator switch incorporated.  
Acoustic version (INS) with silencer integrated at the fan discharge, to reduce outlet noise level.  
All model suitable for air stream temperature up to 120°C continuous.

#### Motors

4 pole motors, three phase 400V-50Hz, IP55, Class F with PTC.  
Speed controllable by frequency drive.  
The electrical installation must be equipped with a security system which allows the maximum speed of the fans in case of fire and disconnects PTC.

#### On request

4/8 and 4/6 pole motors.

#### Specific applications



Approved to  
EN12101-3  
standard  
Certificate n°  
0370-CPD-0347

## TECHNICAL CHARACTERISTICS

Model type	Speed (rpm)	Maximum absorbed power (kW)	Maximum absorbed current 400V (A)	Maximum airflow (m³/h)	SPL* (dB(A)) Outlet	Weight (kg)
STANDARD VERSION						
CTVT/4-632-5,5	1465	6,10	10,9	18.000	84	177
CTVT/4-631-7,5	1480	6,67	12,4	20.700	85	180
CTVT/4-712-11	1470	12,25	21,3	26.000	88	267
CTVT/4-711-15	1480	16,39	29,5	32.500	90	303
CTVT/4-802-18,5	1480	19,85	34,5	35.400	91	361
CTVT/4-801-22	1485	26,00	43,6	44.500	93	376
CTVT/4-902-30	1485	30,16	58,0	50.900	94	515
ACOUSTIC VERSION (INS)						
CTVT/4-632-5,5-INS	1465	6,10	10,9	18.000	78	221
CTVT/4-631-7,5-INS	1480	6,67	12,4	20.700	79	224
CTVT/4-712-11-INS	1470	12,25	21,3	26.000	81	357
CTVT/4-711-15-INS	1480	16,39	29,5	32.500	83	393
CTVT/4-802-18,5-INS	1480	19,85	34,5	35.400	84	492
CTVT/4-801-22-INS	1485	26,00	43,6	44.500	87	507
CTVT/4-902-30-INS	1485	30,16	58,0	50.900	87	635

\* Max. sound pressure level measured at 3m, in hemispherical radiation.

**PERFORMANCE CURVES - ACOUSTIC CHARACTERISTICS**

- $q_v$ : Airflow in  $m^3/h$ .
- $p_{sf}$ : Static pressure in Pa.
- P: Input power in W.
- Sound pressure level @ 3 m, hemispherical radiation, in dB(A).
- Performance data in accordance with ISO 5801.

CTVT/4-632-5,5

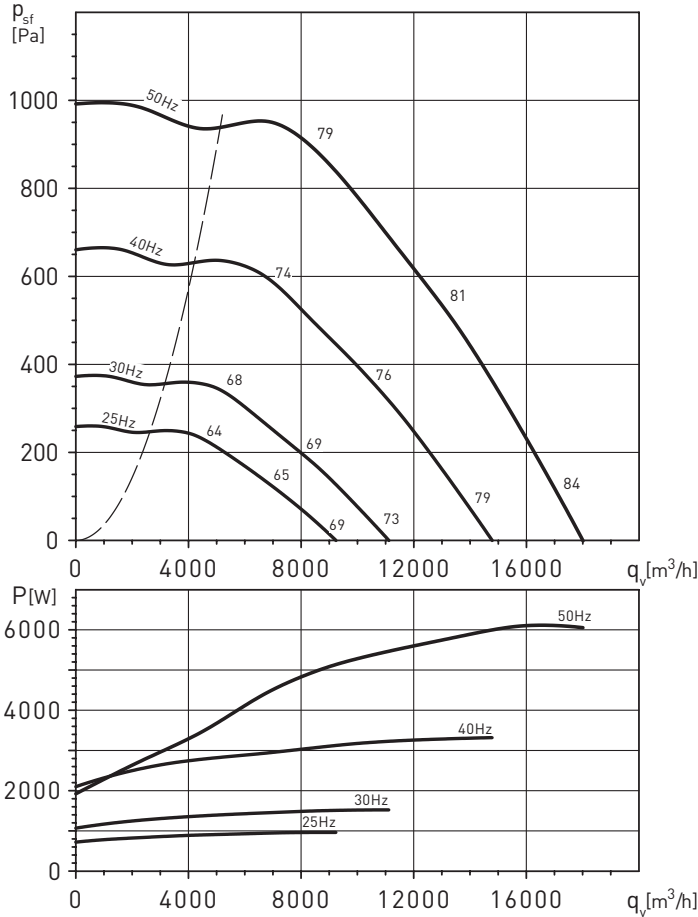

CTVT/4-631-7,5

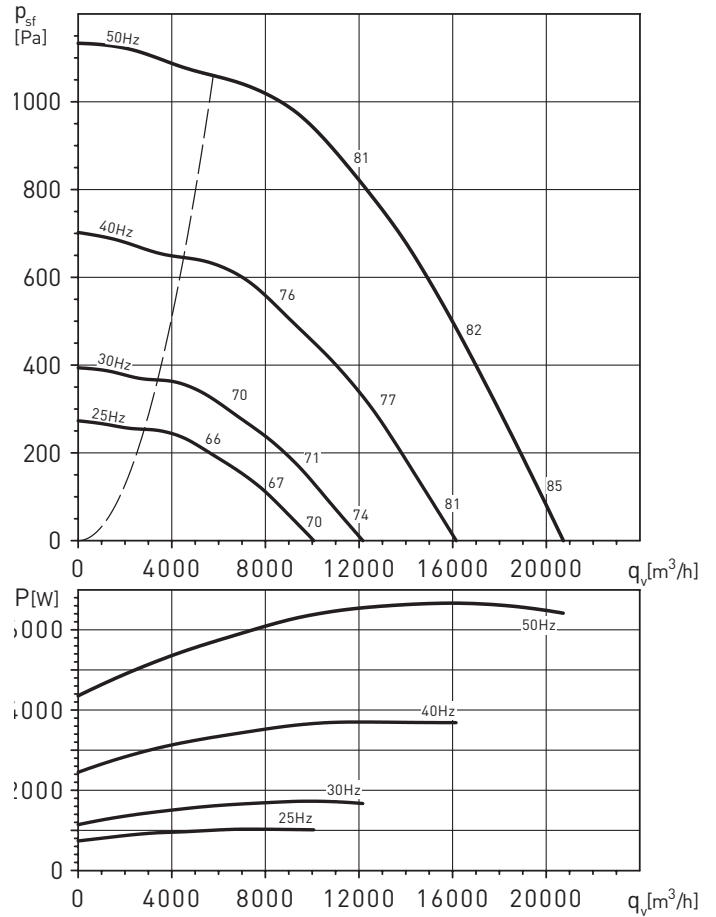

Sound power spectrum: Standard version sound power spectrum LwA, at the fan outlet.

OUTPUT		63	125	250	500	1000	2000	4000	8000	STD*	INS*
50Hz	LP	74	82	96	93	93	97	90	80	101	96
	MP	70	81	95	90	91	90	84	76	98	92
	HP	70	80	93	89	90	87	81	75	97	89
40Hz	LP	69	77	91	88	88	92	85	75	96	91
	MP	65	76	90	85	86	85	79	71	93	87
	HP	65	75	89	84	85	83	76	70	92	84
30Hz	LP	63	71	84	82	82	86	79	69	90	84
	MP	59	70	84	79	79	79	72	65	87	81
	HP	59	69	82	78	79	76	70	64	86	78
25Hz	LP	59	67	80	78	78	82	75	65	86	80
	MP	55	66	80	75	76	75	69	61	83	77
	HP	55	65	78	74	75	72	66	60	82	74

\* STD: Standard version - INS: Acoustic version

Sound power spectrum: Standard version sound power spectrum LwA, at the fan outlet.

OUTPUT		63	125	250	500	1000	2000	4000	8000	STD*	INS*
50Hz	LP	75	84	97	95	95	98	92	82	103	97
	MP	72	83	95	92	93	92	85	77	99	94
	HP	72	82	95	91	92	89	83	77	99	92
40Hz	LP	71	79	92	90	90	93	87	77	98	92
	MP	67	78	91	87	88	87	81	73	95	89
	HP	67	77	90	86	87	84	79	72	94	87
30Hz	LP	64	73	86	84	84	87	81	71	92	86
	MP	61	72	84	81	81	80	74	66	88	83
	HP	61	71	84	80	81	78	72	66	87	80
25Hz	LP	60	69	82	80	80	83	77	67	88	82
	MP	57	68	80	77	78	76	70	62	84	79
	HP	57	67	80	76	77	74	68	62	84	77

\* STD: Standard version - INS: Acoustic version

**PERFORMANCE CURVES - ACOUSTIC CHARACTERISTICS**

- $q_v$ : Airflow in  $m^3/h$ .
- $p_{sf}$ : Static pressure in Pa.
- P: Input power in W.
- Sound pressure level @ 3 m, hemispherical radiation, in dB(A).
- Performance data in accordance with ISO 5801.

CTVT/4-712-11

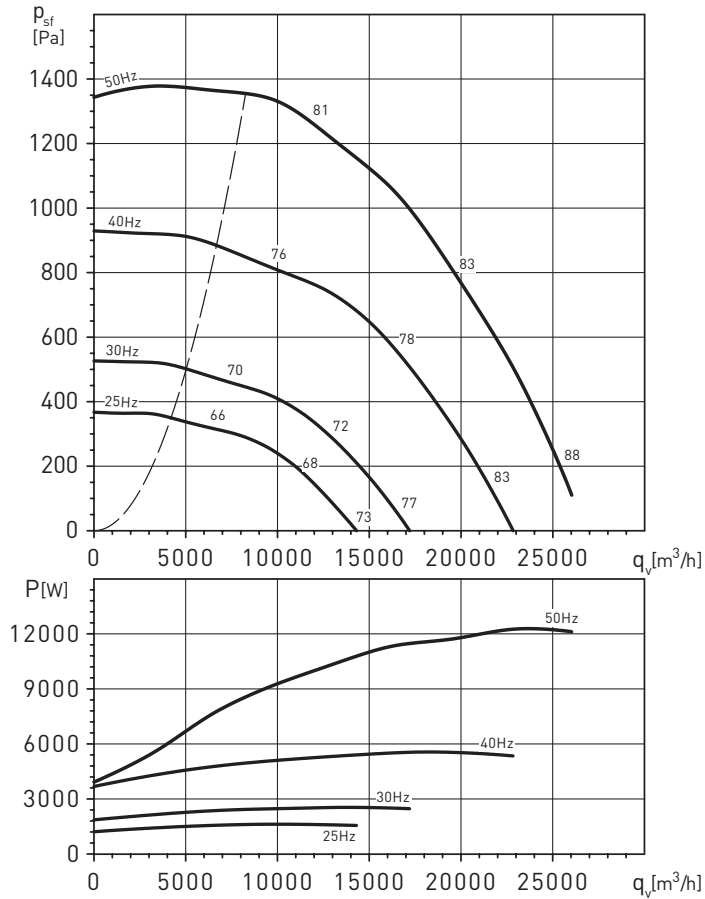

CTVT/4-711-15

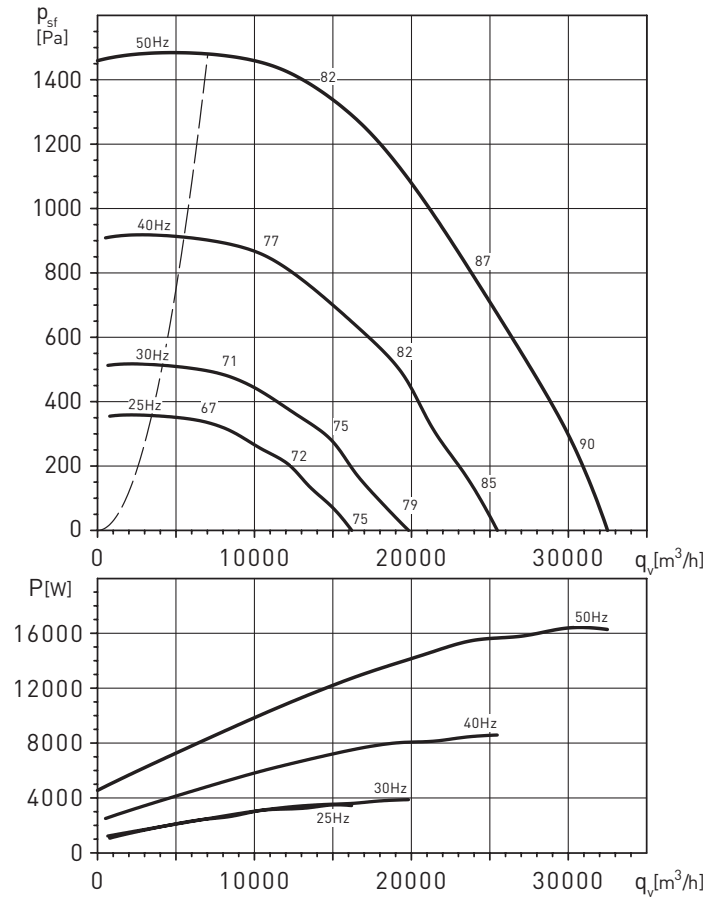

Sound power spectrum: Standard version sound power spectrum LwA, at the fan outlet.

OUTPUT		63	125	250	500	1000	2000	4000	8000	STD*	INS*
50Hz	LP	78	87	97	98	99	100	95	86	105	99
	MP	73	85	94	95	95	93	88	79	101	95
	HP	72	84	93	92	93	89	84	77	98	91
40Hz	LP	73	82	92	93	94	95	91	81	101	94
	MP	68	80	90	90	90	88	83	74	96	91
	HP	67	80	88	88	88	84	79	72	94	87
30Hz	LP	66	76	86	87	88	89	84	74	94	88
	MP	62	74	83	84	84	82	77	68	90	84
	HP	61	73	82	81	81	78	73	66	87	80
25Hz	LP	62	72	82	83	84	85	80	70	90	84
	MP	58	70	79	80	80	78	73	64	86	80
	HP	57	69	78	77	77	74	69	62	83	76

\* STD: Standard version - INS: Acoustic version

Sound power spectrum: Standard version sound power spectrum LwA, at the fan outlet.

OUTPUT		63	125	250	500	1000	2000	4000	8000	STD*	INS*
50Hz	LP	79	90	98	101	102	102	98	88	107	101
	MP	76	89	95	99	99	96	91	82	104	100
	HP	73	87	93	94	94	90	86	77	100	93
40Hz	LP	74	85	93	96	97	97	93	83	103	96
	MP	72	84	91	94	94	91	86	77	99	95
	HP	69	82	88	90	89	85	81	73	95	88
30Hz	LP	68	79	87	90	91	90	87	77	96	90
	MP	65	77	84	88	88	85	80	71	93	89
	HP	62	76	81	83	83	79	74	66	88	82
25Hz	LP	64	75	83	86	87	86	83	73	92	86
	MP	61	74	80	84	84	81	76	67	89	85
	HP	58	72	77	79	79	75	71	62	84	78

\* STD: Standard version - INS: Acoustic version

**PERFORMANCE CURVES - ACOUSTIC CHARACTERISTICS**

- $q_v$ : Airflow in  $m^3/h$ .
- $p_{sf}$ : Static pressure in Pa.
- P: Input power in W.
- Sound pressure level @ 3 m, hemispherical radiation, in dB(A).
- Performance data in accordance with ISO 5801.

CTVT/4-802-18,5

CTVT/4-801-22

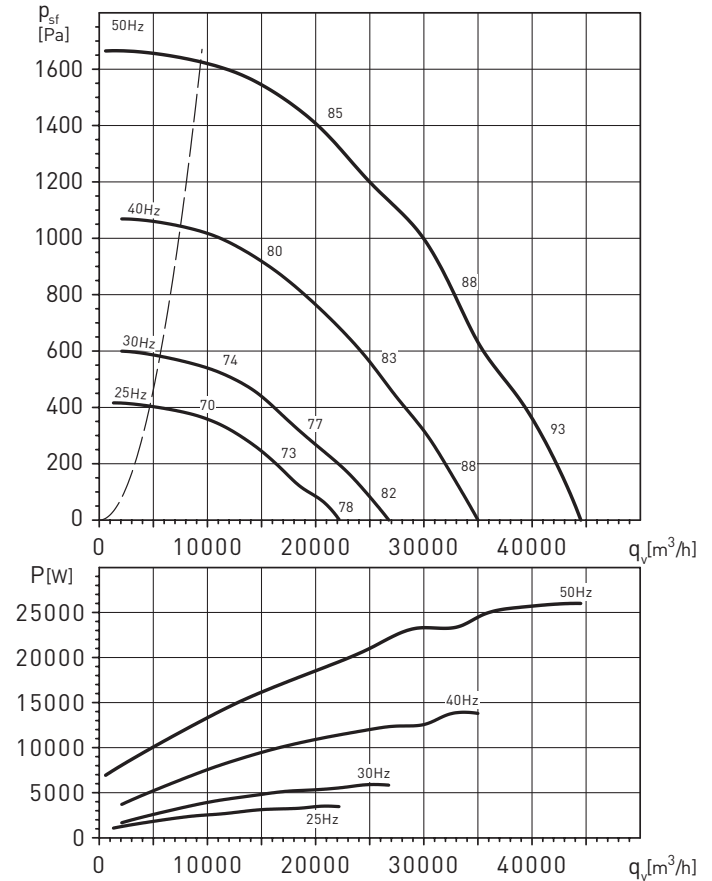
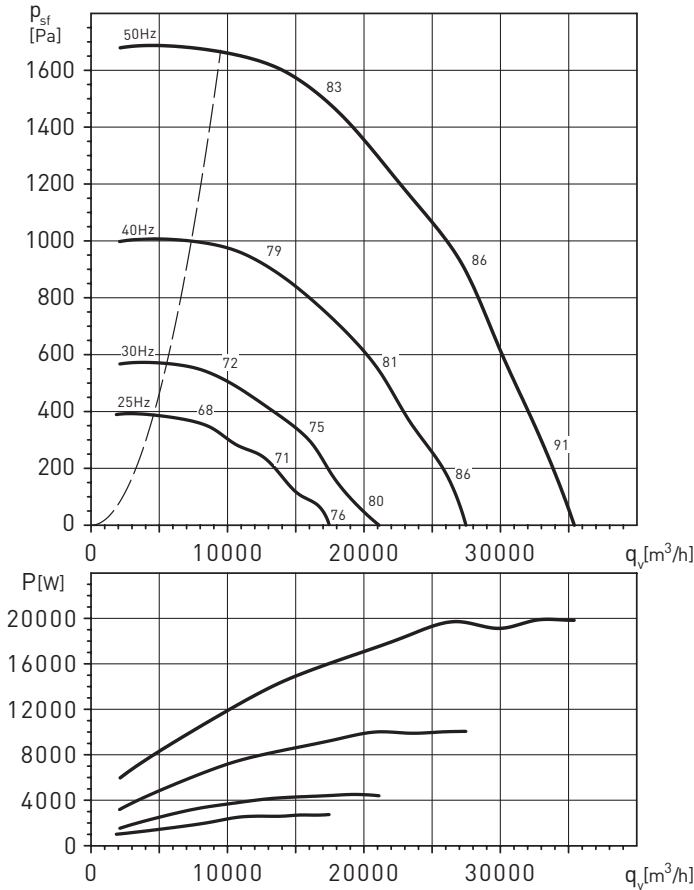

Sound power spectrum: Standard version sound power spectrum LwA, at the fan outlet.

Sound power spectrum: Standard version sound power spectrum LwA, at the fan outlet.

OUTPUT	63	125	250	500	1000	2000	4000	8000	STD*	INS*	
50Hz	LP	80	91	98	102	103	102	99	89	108	102
	MP	76	88	94	99	99	95	91	82	104	99
	HP	75	89	93	96	95	91	87	79	101	96
40Hz	LP	75	86	93	97	98	98	94	85	104	97
	MP	71	84	89	94	94	91	86	77	99	94
	HP	70	84	88	91	90	87	82	74	96	91
30Hz	LP	69	80	87	91	92	91	88	78	97	91
	MP	65	77	83	88	88	84	80	70	93	88
	HP	64	78	82	85	84	80	76	68	90	84
25Hz	LP	65	76	83	87	88	87	84	74	93	87
	MP	61	73	79	84	84	80	76	66	89	84
	HP	60	74	78	81	80	76	72	64	86	80

OUTPUT	63	125	250	500	1000	2000	4000	8000	STD*	INS*	
50Hz	LP	82	94	99	105	106	104	102	92	111	104
	MP	78	90	95	101	101	97	93	83	106	102
	HP	76	91	94	98	97	93	89	80	102	98
40Hz	LP	77	89	95	100	101	99	97	87	106	99
	MP	73	85	90	96	96	92	88	78	101	97
	HP	72	86	89	93	92	88	84	75	98	93
30Hz	LP	71	82	88	94	95	93	91	81	100	93
	MP	66	79	83	90	90	86	82	72	94	90
	HP	65	80	83	87	86	82	78	69	91	87
25Hz	LP	67	79	84	90	91	89	87	77	96	89
	MP	63	75	80	86	86	82	78	68	90	87
	HP	61	76	79	83	82	78	74	65	87	83

\* STD: Standard version - INS: Acoustic version

\* STD: Standard version - INS: Acoustic version

### PERFORMANCE CURVES - ACOUSTIC CHARACTERISTICS

- $q_v$ : Airflow in  $m^3/h$ .
- $p_{sf}$ : Static pressure in Pa.
- P: Input power in W.
- Sound pressure level @ 3 m, hemispherical radiation, in dB(A).
- Performance data in accordance with ISO 5801.

CTVT/4-902-30

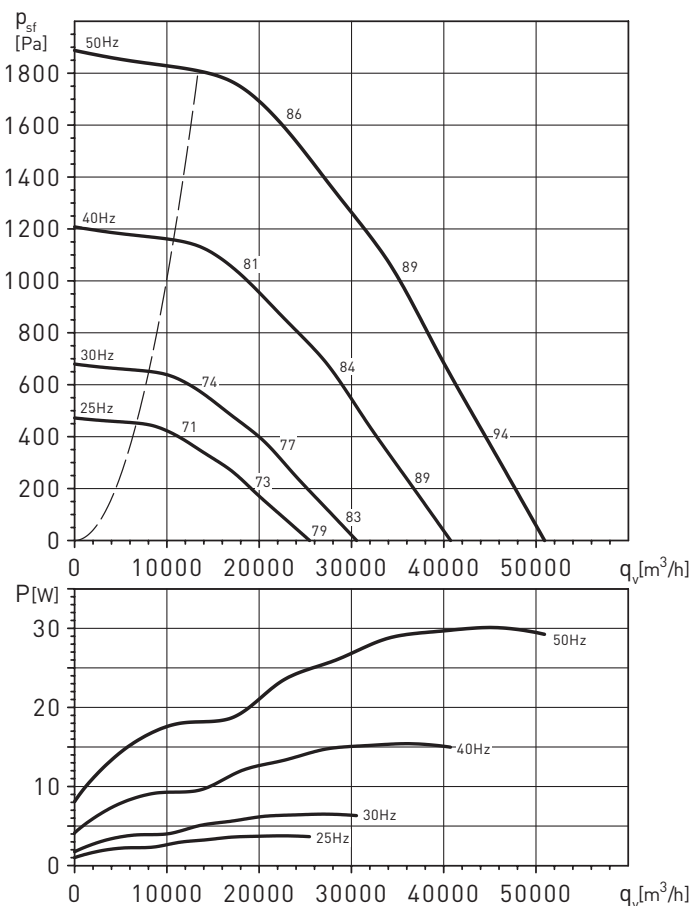

Sound power spectrum: Standard version sound power spectrum LwA, at the fan outlet.

OUTPUT		63	125	250	500	1000	2000	4000	8000	STD*	INS*
50Hz	LP	83	95	100	106	107	105	103	93	112	105
	MP	78	91	95	101	101	97	93	84	106	102
	HP	77	92	94	99	97	93	89	80	103	99
40Hz	LP	78	90	96	101	102	100	98	88	107	100
	MP	73	86	90	97	97	92	89	79	101	97
	HP	72	87	90	94	93	89	85	76	98	94
30Hz	LP	72	83	89	95	96	94	92	82	101	94
	MP	67	80	84	90	90	86	82	72	95	91
	HP	66	81	83	88	86	82	78	69	92	88
25Hz	LP	68	80	85	91	92	90	88	78	97	90
	MP	63	76	80	86	86	82	78	68	91	87
	HP	62	77	79	84	82	78	74	65	88	84

\* STD: Standard version - INS: Acoustic version

**DIMENSIONS (mm)**

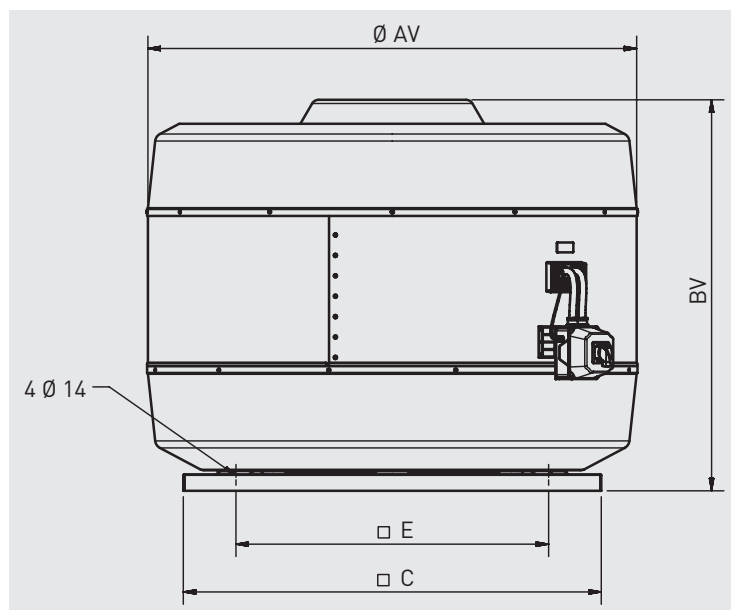

**CTVT Standard version**

Model	AV	BV	C	E
CTVT/4-632-5,5	1216	930	905	750
CTVT/4-631-7,5	1216	930	905	750
CTVT/4-712-11	1485	1146	1270	950
CTVT/4-711-15	1485	1188	1270	950
CTVT/4-802-18,5	1485	1207	1270	950
CTVT/4-801-22	1485	1225	1270	950
CTVT/4-902-30	1485	1345	1270	950

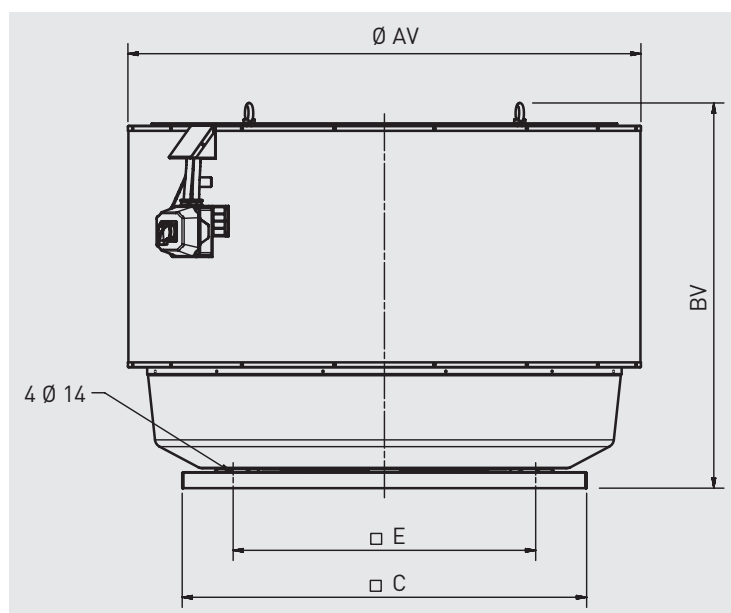

**CTVT INS Acoustic version**

Model	AV	BV	C	E
CTVT/4-632-5,5-INS	1342	978	905	750
CTVT/4-631-7,5-INS	1342	978	905	750
CTVT/4-712-11-INS	1611	1163	1270	950
CTVT/4-711-15-INS	1611	1250	1270	950
CTVT/4-802-18,5-INS	1611	1274	1270	950
CTVT/4-801-22-INS	1611	1292	1270	950
CTVT/4-902-30-INS	1611	1432	1270	950

**MOUNTING ACCESSORIES**

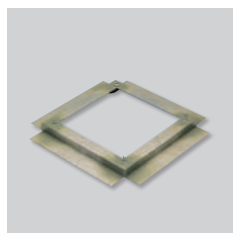

**JMS**

**Sealing frame**

- For mounting a roof fan on an up stand or base.
- Supplied with screws and gasket for a complete weatherproof seal.

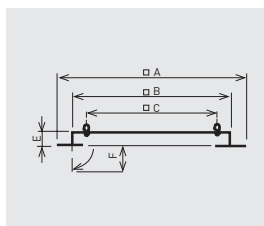

Model	□A	□B	□C	E	F
JMS-905	1065	885	750	60	70
JMS-1250	1410	1230	950	60	70

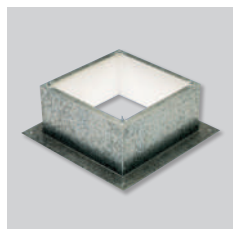

**JBS/JBS-V**

**Flat roof up stand**

- For mounting a fan on a flat roof without up stands.
- For use on horizontal roofs.
- Internal insulation to prevent condensation.
- Supplied with screws and gasket for a complete weather seal.

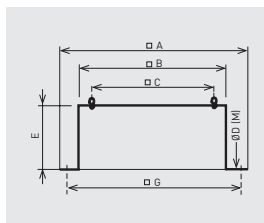

Model	□A	□B	□C	Ø D (M)	E	□G
JBS-905	1065	884	750	16 (M10)	400	975
JBS-V-1000	1447	1247	950	18 (M12)	400	1347

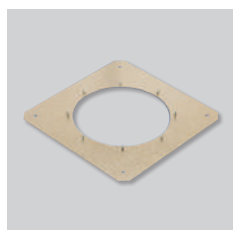

**JPA**

**Accessory adapter plate**

- Used when mounting the accessories (JCA, JBR, JAE).
- Allows the fan to be disconnected from the upstand without having to remove the duct.

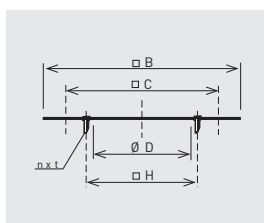

Model	□B	□C	Ø D	next	Ø H
JPA-905	884	750	633	12xM10	690
JPA-1250	1230	950	1000	8xM12	1070



**JCA N**

**Backdraft shutter**

- Prevents backdraft when the fan is not operating.
- To be mounted at the fan inlet with the JPA plate.

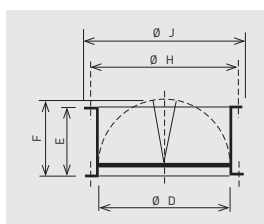

Model	Ø D	E	F	Ø H	Ø J
JCA-905 N	633	345	365	690	714
JCA-1250 N	1004	560	560	1070	1110



**JBR N**

**Flange**

- For use when circular connection is required directly to the fan.
- To be mounted at the fan inlet with the JPA plate or fixed directly to the fan base (rivets or screws not supplied).

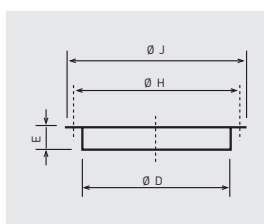

Model	Ø D	E	Ø H	Ø J
JBR-905 N	633	55	690	714
JBR-1250 N	1004	60	1070	1110



**JAE N**

**Flexible coupling**

- Reduces the transmission of vibrations when the duct is connected directly to the fan.
- To be mounted at the fan inlet with JPA plate.

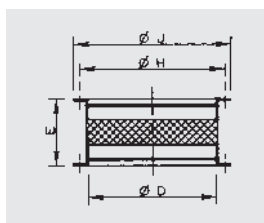

Model	Ø D	E	Ø H	Ø J
JAE-905 N	633	164	690	714
JAE-1250 N	1004	185	1070	1110

**MOUNTING ACCESSORIES - INSTALLATION**

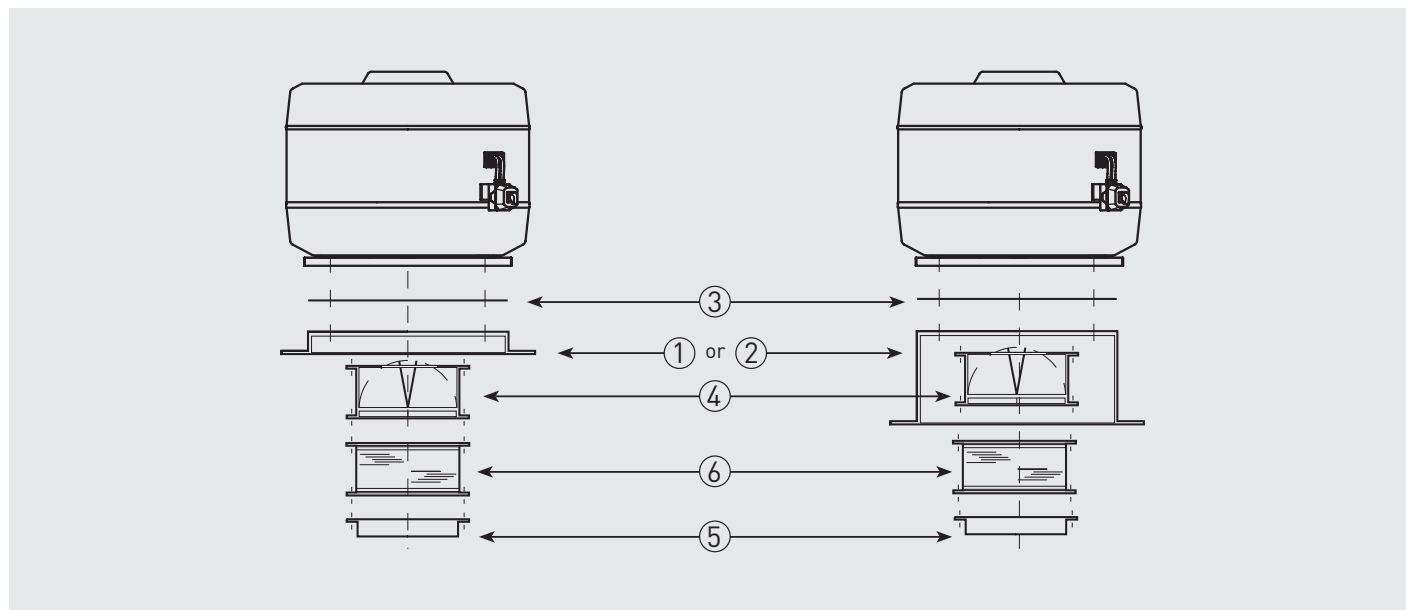

Fan model	1 Sealing frame	2 Flat roof insulated up stand	3 Accessory adapter plate	4 Back draft shutter	5 Flange with spigot	6 Flexible coupling
CTVT/4-632	JMS-905	JBS-905	JPA-905	JCA-905 N	JBR-905 N	JAE-905 N
CTVT/4-631						
CTVT/4-712	JMS-1250	JBS-V-1000	JPA-1250	JCA-1250 N	JBR-1250 N	JAE-1250 N
CTVT/4-711						
CTVT/4-802						
CTVT/4-801						
CTVT/4-902	JMS-1250	JBS-V-1000	JPA-1250	JCA-1250 N	JBR-1250 N	JAE-1250 N